

Special Contribution

Development of High-Power Blue Laser Diodes

Principal Researcher
LD Business Division,
Optoelectronics Products Business Unit,
NICHIA CORPORATION

Ph. D. (Engineering) *Shinichi Nagahama*



ABSTRACT With the aim of applying the blue laser diode to the laser processing, we have developed the high-power Gallium Nitride-based (GaN-based) blue laser diodes. Starting from the technical findings of the existing GaN laser diodes for display applications, we achieved the high output power of 11.2 W, the highest value in the world for an optical output power per single emitter of a GaN-based blue laser diode, by optimizing the device structure and adapting a new package with low-thermal resistance. In addition, from the results of each reliability evaluation, we confirmed that the Blue Laser Diode which we have developed is promising for its greatly high optical output stability and low failure rate, and therefore the device that is sufficiently practical as the light source for the laser processing.

1. INTRODUCTION

In the laser processing field, the visible-light laser of blue to green color, which has a high absorbing ratio in the metallic materials, such as pure copper, is the focus of our attention. There are some candidates for the materials and device configurations to obtain the blue to green color laser. However the direct emission by a laser diode using GaN-based materials being the most high efficiency and a simple configuration, its development is intensified in recent years¹⁾⁻³⁾. For the GaN-based laser diodes, its epitaxial layers can be made from $\text{Al}_x\text{Ga}_y\text{In}_{1-x-y}\text{N}$ and its band gap at room temperature is from 0.8 eV of InN to 6.2 eV of AlN, therefore it is theoretically a direct-transition semiconductor which can cover not only over the range from blue to green but also over all ranges of visible light. Since 1995 when the laser emission (wavelength: 410nm)⁴⁾ by current injection was achieved for the first time with this material, its performance as a device has been drastically improved, and this laser became widely used as the light source for large capacity optical disk devices as represented by Blue-ray DiscTM. In recent years, the range of emission wavelength is expanding from blue⁵⁾ to green⁶⁾, and it is widely used as the light sources for displays such as projectors. Since 2000, we have been developing the high output and high efficiency blue and green GaN-based laser diodes as light sources for displays. Figure 1 shows the optical output and Wall Plug Efficiency (WPE) improvement of our developed blue laser diodes for displays. The optical output and WPE of the blue laser diode were 0.5 W and 20%⁷⁾ in 2006 and

then we have improved up to approximately 10 times at 5.67 W optical output and approximately 2.5 times at 48% WPE in 2020 with the introduction of several new element technologies for efficiency improvement⁸⁾.

With the aim of the laser diode's application to the optical light source of laser processing, this time, we considered, based on the technical findings of the GaN-base laser diodes for displays, to increase its output power. As a result, we were able to develop the blue laser diode which has an optical output over 10 W. In this section, we report the manufacturing method and characteristics of this high output blue laser diodes.

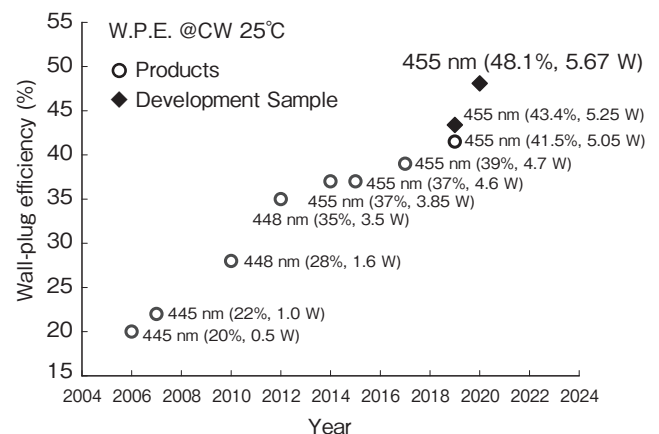

Figure 1 Output power and WPE improvement of the blue laser diodes.

2. MANUFACTURE OF THE HIGH-POWER BLUE LASER DIODE

Figure 2 shows the schematic structure of the blue laser diode which we have developed. It consists of an $\text{Al}_x\text{Ga}_y\text{In}_{1-x-y}\text{N}$ crystal and an InGaN multiple quantum well layer which is used as an emission layer. Using a high quality C-plane GaN free-standing substrate, it is possible to grow the epitaxial layers with low dislocation density similar to the substrate. Since the c-plane GaN substrate has cleavableness, the front and rear facets of the laser diode can be manufactured easily by cleaving the substrate. The structure of the laser device is a general index-guided ridge stripe structure, and by covering the outer laterals of the ridge stripe with dielectric insulating film, the device controls its transverse mode with a refractive index difference in the horizontal direction. We set the ridge stripe width at $90\ \mu\text{m}$ to obtain the optical output of more than 10 W with one single emitter. That means, we considered the coupling to the optical fiber with a $100\ \mu\text{m}$ diameter core of a general delivery fiber, while reducing the optical density by widening the output beam width of the laser to avoid the occurrence of errors by the Catastrophic Optical Damage (COD) which is a particular failure mode of general laser diodes. On the other hand, to control the vertical lateral mode, we employed the Separate-Confinement Heterostructure (SCH) which efficiently confines carriers and optical light respectively to the InGaN multi-quantum well emission layer and to the n- and p-guide layers.

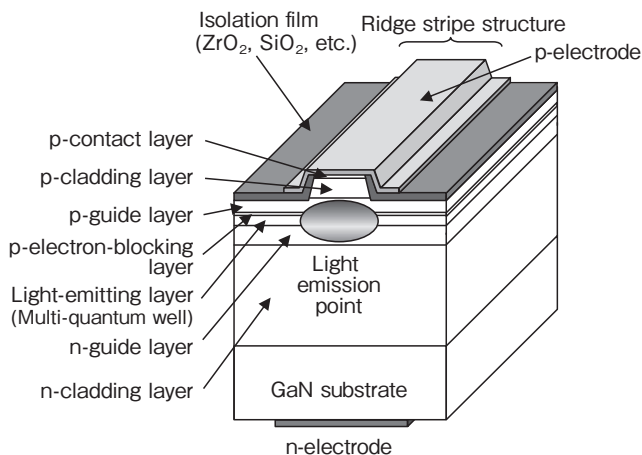

Figure 2 Schematic structure of a blue laser diode.

With respect to the package which the laser device is assembled, the TO-CAN Package of 9 mm-outer diameter is often used for a display purpose. The design of this package was optimized with the goal of down-sizing, therefore its heat exhausting resistance is high, and the increasing junction temperature causes a problem when a high output laser diode with more than 10 W optical output is driven. Since the laser diode's increasing temperature generates harmful effects such as degradation of the

optical output or its lifetime, we developed a new package, the Side Lead Package (SLP) which has a heat resistance reduced. The presentation of the SLP is shown in Figure 3. The SLP is a metal package using copper material and is hermetically sealed by a seam welding of the upper lid. The outside dimensions are 6.9 mm (width), 6.0 mm (depth) and 6.55 mm (height). Placing the feeding lead pins on the lateral side of the package, it is easy to exhaust heat from the bottom of the package. The heat resistance value of the blue laser diode using this SLP is 2.3 K/W. This value has been reduced drastically in comparison to a blue laser diode of displays' use (the TO-CAN Package of 9 mm-outer diameter, 5.6 K/W heat resistance) which is commercialized currently.

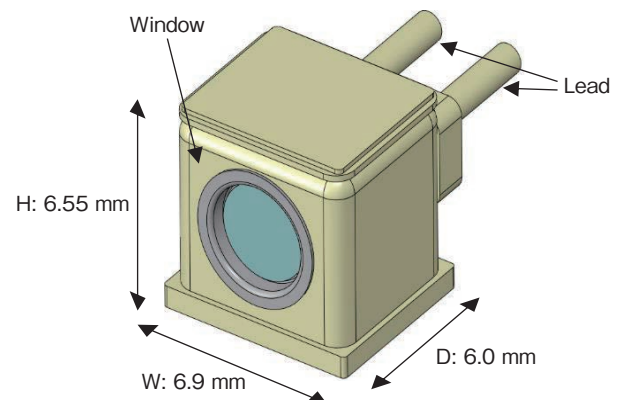

Figure 3 Presentation of the SLP.

3. CHARACTERISTICS OF THE HIGH-POWER BLUE LASER DIODES

3.1 Basic Characteristics of the High-Power Blue Laser Diodes

Figure 4 shows the typical temperature dependency of the light-current (L-I) characteristic and voltage-current (V-I) characteristic of the high-power blue laser diode. Under the continuous wave (CW) driving, we measured them with varying the temperature of the SLP's bottom. From the dependency of the L-I characteristic, a drastic decrease of the slope efficiency ($\eta_s = \Delta L / \Delta I$) is not seen until a 10 A of injection current even though the package's temperature becomes as high as 80°C . Especially under a driving when the package's temperature is 40°C or less, it is found that incredibly good temperature characteristics is achieved. The optical output, at the room temperature with the rated current value ($I_{op}=8.5\ \text{A}$), is 11.2 W and the WPE is 33.8%. With optimization of the laser chip and Introduction of the low-heat resistance package, a high optical output value of 11.2 W is obtained. As far as we can tell, this is the world's best optical output per one single device of one single emitter with a GaN-based blue laser diode.

Figure 5 shows the wavelength spectra of the blue laser diode. The peak wavelength is 465 nm. The longitudinal

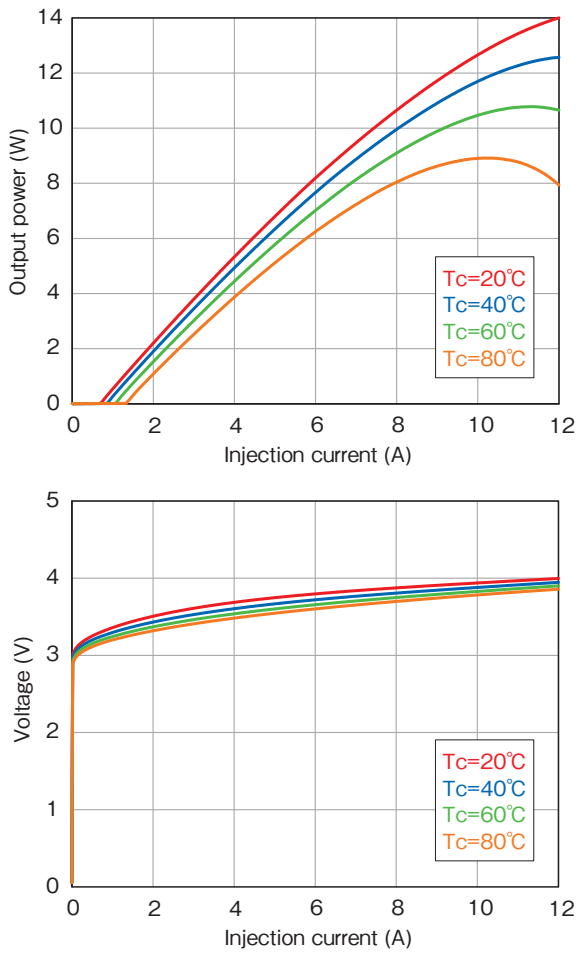

Figure 4 Typical L-I and V-I characteristics of the blue laser diode.

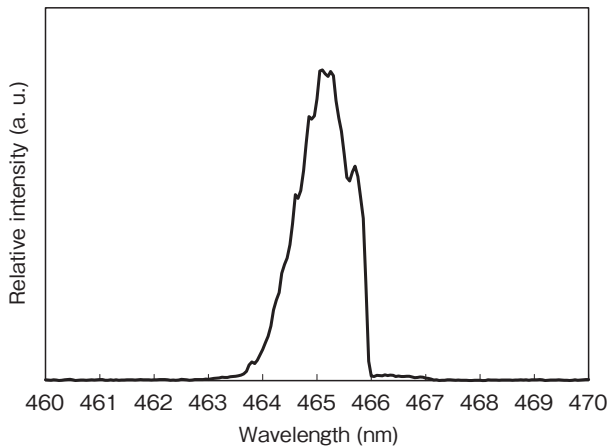

Figure 5 Wavelength spectra of the blue laser diode.

mode is multimode and the envelope of the spectra is approx. 2 - 3 nm. We controlled the In composition ratio of the InGaN multi-quantum well.

The Far Field Pattern (FFP) and the Near Field Pattern (NFP) of the blue laser diode are shown in Figure 6 and Figure 7 respectively. In Figure 6, the beam intensity provides a Gaussian-like shape distribution because the vertical lateral mode (b), in a perpendicular direction toward the epitaxial surface, is a single mode. However, the

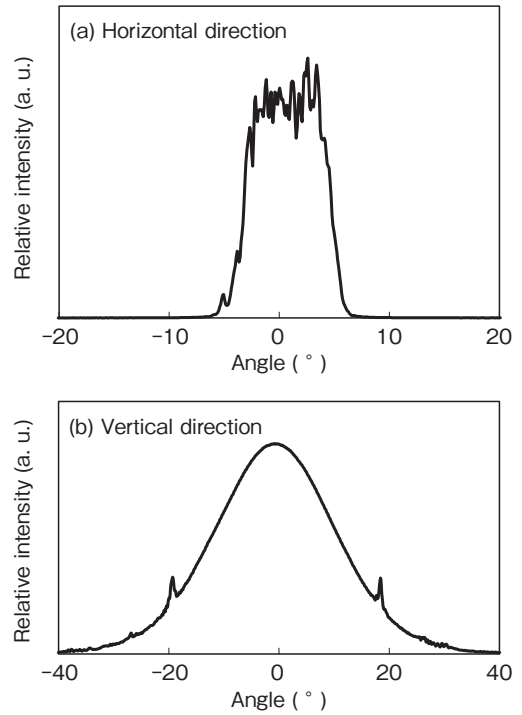

Figure 6 FFPs of the blue laser diode in (a)Horizontal direction and in (b)Vertical direction.

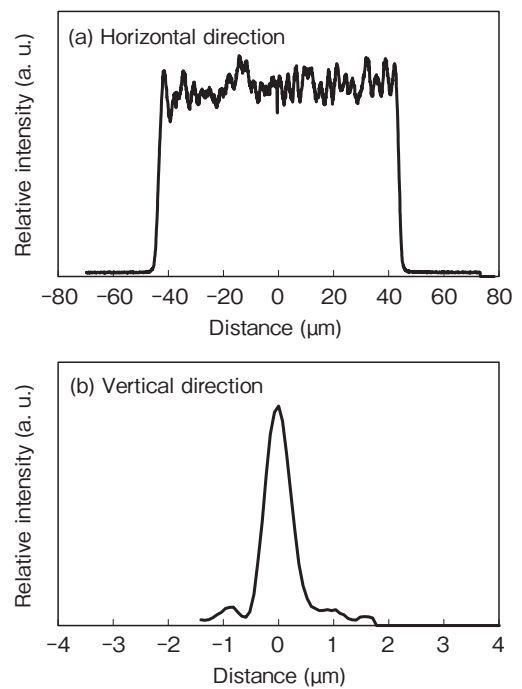

Figure 7 NFPs of the blue laser diode in (a)Horizontal direction and in (b)Vertical direction.

beam intensity provides a rectangular-like shape because the horizontal transverse mode (a), in a horizontal direction, is multi-mode. As defining a beam divergence angle as the angle where the beam becomes $1/e^2$ of the peak intensity, the angle is 44° in a vertical direction and 10° in a horizontal direction. From the intensity distribution of the NFP in Figure 7, the size of the light emission point is approx. $1 \mu\text{m}$ in a vertical direction and approx. $89 \mu\text{m}$, which corresponds to the ridge stripe width of the laser

chip, in a horizontal direction, and it is found that the optical intensity especially in a horizontal direction is emitting almost uniformly. By adapting a ridge stripe structure of the laser diode and maintaining stable high order modes with refractive index differences in a horizontal direction, the laser diode is designed so that its NFP in a horizontal direction becomes uniform. Generally, a non-uniform distribution of a NFP induces a sudden COD where the optical power intensity is locally high and it leads to a failure of the laser diode in a short time. The NFP control for a uniform distribution is the one of the important technology aspects to ensure a high reliability.

3.2 Reliability of the High-Power Blue Laser Diodes

With respect to degradation modes of the GaN-based laser diode, there are two modes namely: a gradual degradation and a sudden failure. Gradual degradation is a similar degradation mode as the one which general emission devices have and its life prediction is available from the Arrhenius Model as an acceleration from the junction temperature of the device. In order to measure the optical output deterioration from the gradual degradation, reliability tests on the blue laser diodes have been conducted and results are shown in Figure 8. In the tests, the laser diodes were driven with the CW and an Auto Current Control (ACC) and the temporal change of its optical output is monitored over 4000 hours. In Figure 8, test conditions are (a) rated condition (current = 8.5 A, package temperature = 40°C), (b) temperature accelerating condition of injection current (current = 8.5 A, package temperature = 60°C), and (c) current accelerating condition of the rated current (current = 10.5A, package temperature = 40°C). Under all the test conditions, the optical output decrease is within 1 to 2% of the initial value after 4000 hour-driven and an extremely high stability is obtained. Under the rated condition drive, the deterioration percentage of the optical output is significantly small and the optical output under the ACC drive is stable.

Next, we describe the sudden failure of the developed blue laser diodes. The main cause of a sudden failure of a GaN-based laser diode is the COD. The COD is a particular phenomenon of general laser diodes and it occurs with causes such as a deterioration of the passivation layer at the front facet, a carrier recombination at a surface, and a temperature increase by the optical absorption around the front facet. As defining the time until the COD occurs as the COD lifetime, the COD lifetime strongly depends on the optical power density at the front facet. From our previous findings, it is found, as a rule of thumb, that the COD lifetime of the GaN-based blue laser diodes is proportional to the optical output power density at the front facet. The graph in Figure 9 shows an estimation for the COD lifetime of the blue laser diodes which we developed on the basis of the findings of blue laser diodes for display applications. In Figure 9, the horizontal axis shows the optical output power density at the front facet and the vertical axis shows the COD lifetime. Since the optical output power density at the front facet of the

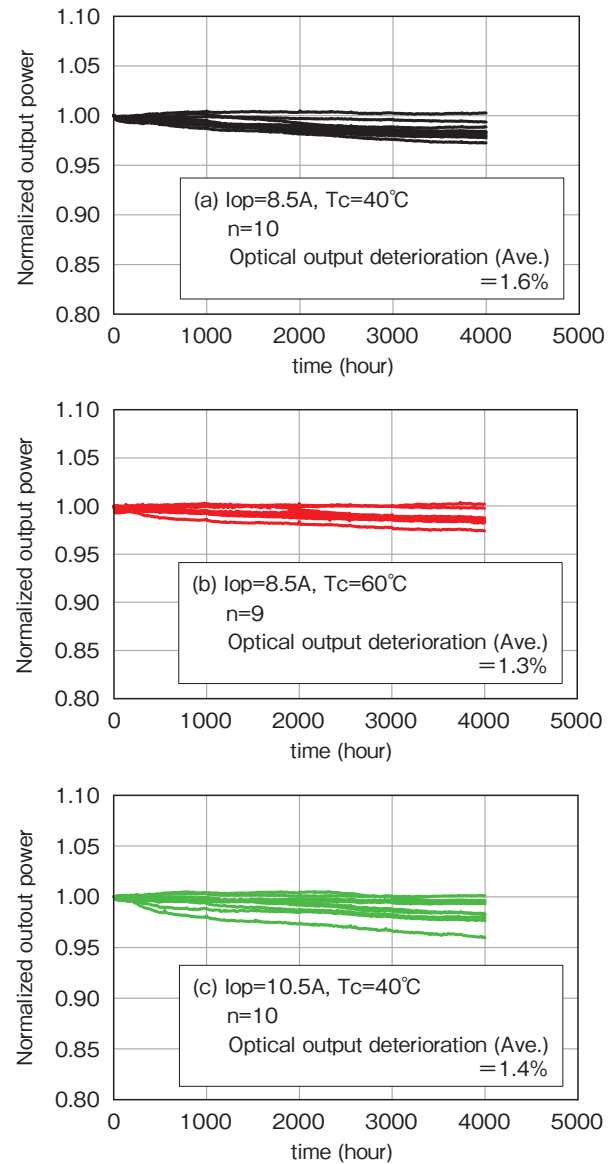

Figure 8 Lifetime test results of the blue laser diodes.

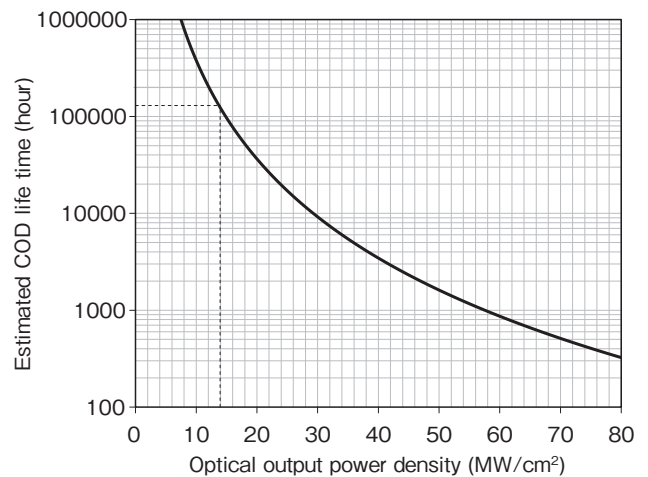

Figure 9 Relationship between COD lifetime and optical output power density on the front facet of the blue laser diodes.

blue laser diode developed this time is approx. 14 MW/cm², the estimated average of the COD lifetime is approx. 130,000 hours. In consideration of the mounting to a laser processing machine, it seems that the probability of COD occurrence of the blue laser diodes in the field is extremely low.

Regarding a light source for the laser processing, a high stability of optical output power and a small failure rate are required. From the results of the these reliability tests, a considerably high optical output stability and a low failure rate are promising in the developed blue laser diodes and it is considered that these blue laser diodes can be significantly sustainable for the field use as the laser processing light source.

4. CONCLUSION

With aim of mounting on a laser processing machine, we developed high-power blue laser diodes by using GaN-based semiconductor materials. By optimizing epitaxial layers and a device structure, and mounting it in the new package, SLP, with a low thermal-resistance, we achieved the blue laser diode which has the high optical output of 112 W and the high WPE of 33.8%. From the results of the reliability tests on the developed blue laser diodes, we also confirmed that these laser diodes have sufficient reliability for the field use as the light source for the laser processing. The application of the blue laser diodes to the laser processing for hard-to-work materials such as copper has started only just recently. We would like to accelerate the application of the blue laser diodes to laser processing by achieving much higher output power and much higher efficiency thereafter.

REFERENCES

- 1) Y. Ishige, et. al., Proc. SPIE 11668 (2021) 116680M.
- 2) H. König, et. al., Proc. SPIE 11262 (2020) 112620Q.
- 3) S. Nozaki, et. al., Proc. SPIE 11262 (2020) 112620S.
- 4) S. Nakamura, et. al., Jpn. J. Appl. Phys. 35, (1996) L74-L76.
- 5) S. Nagahama, et. al., Appl. Phys. Lett. 79, (2001) 1948-1950.
- 6) T. Miyoshi, et. al., Appl. Phys. Exp. 2, (2009) 062201-062203.
- 7) T. Miyoshi, et. al., SID Digest (2006) 1915-1917.
- 8) Y. Nakatsu, et. al., Proc. SPIE 11280, (2020) 112800S 1-7.