

## Development of a Light Emitting Component for a Luminous Central Venous (CV) Port

Yoshiki Nomura<sup>\*1</sup>, Satoshi Goto<sup>\*1</sup>, Katsuki Suematsu<sup>\*2</sup>,  
Junichi Hasegawa<sup>\*1</sup>, Kazutaka Nara<sup>\*1</sup>, Tsunenori Arai<sup>\*1</sup>

**ABSTRACT** The Central Venous (CV) port, which is implanted under the patient's skin, is used when medications are administered in the chemotherapy or the nutritional therapy. Training to secure puncture site of the CV port under the skin is necessary, and the medical accidents such as incomplete or incorrect punctures are still happening. Therefore, we developed a light emitting accessory for the CV port, which determines the puncture site possible with LEDs lighted by a Wireless Power Transfer (WPT). We performed animal experiments using the developed accessory and confirmed that a safe and secure puncture is available since the puncture site at the CV port can be determined. We have been developing the light emitting accessory for the luminous CV port for production.

### 1. INTRODUCTION

In chemotherapy, a type of cancer treatment, and in nutritional therapy, when the digestive system is not functioning adequately, the administration of medications or nutritional supplements through a CV catheter plays an important role in these treatments. Since CV catheterization may be an risky procedure, and duration of the CV catheter placement should be limited due to the risk of implantation, the CV port is popularly implanted in the patient's body and medications are administrated through the CV port. The CV port device is implanted under the skin of the chest or the upper arm, and the tip of the catheter of which connected to the CV port device is placed in great vein near the heart. The CV port is used about 110,000 pieces/year and becomes the device which plays an important role in the treatment.

The schematic of the CV port is shown in Figure 1. The CV port system consists of a 100-yen coin size device and a catheter. In the upper part of the CV port device, there is a silicon rubber plug called septum and there is a space called reservoir under the septum. The catheter is connected to the reservoir and the CV port device is connected to the central vein through the catheter. When medications are administered through the reservoir and

the catheter, the Huber needle must be punctured into the septum. However the septum location is roughly recognized by finger touch and skin shape, but is not precisely, because the CV port was set under the patient's skin. Currently a nurse detects the CV port under the skin by finger touch while puncturing to the septum. When the punctured Huber needle is out of position against the septum, that is, eccentric puncture and/or oblique puncture, toxic medication sometimes may leak to severely damage surrounding tissue of the CV port device in the case of cancer chemo-therapy. In that severe tissue damage, necrotic tissue should be surgically removed and CV port system is also removed to abandon its usage. An another new CV port device is set opposite side of patient's body. These procedures may reduce patient QOL. We considered that such leakages are caused by the invisibleness of the puncture site in the CV port, and

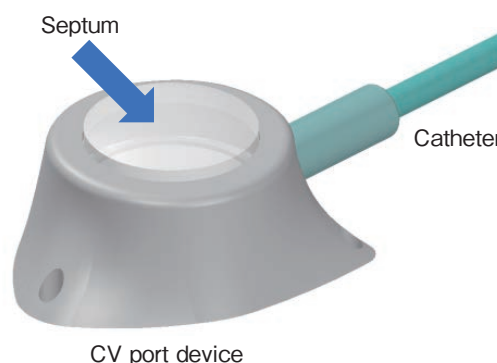

Figure 1 Schematic illustration of the CV port.

<sup>\*1</sup> Global Marketing Sales Division,  
Social Design & New Business Development Department

<sup>\*2</sup> Research & Development Division,  
Telecommunications & Energy Laboratories

therefore, we have an idea to develop a luminous CV port as the means for determining the puncture site not by palpate but by sight. The luminous CV port has a light emitting function in the CV port unit to be able to determine accurately the position of the septum. LEDs, which are compact and have low power consumption, are used as the light source, and power is supplied from outside via a wireless power transfer (WPT) to light up the LEDs. A power receiving circuit of the WPT, and LEDs are mounted in the CV port and the multiple LEDs are placed around the septum to allow visual recognition of the CV port which is even under the skin as well as an easy identification of the center of the septum for the puncture.

This time, we also finished the handling of the associated heat generation<sup>1)</sup> required for implanted medical equipment, therefore we present the details in this paper.

## 2. OUTLINE OF THE POWER SUPPLY SYSTEM

### 2.1 Selection of the Power Supply Method

In a case like this study, to supply the power from outside of the patient's body and to light up the LEDs implanted inside, the LEDs must light up in order to identify the position even if a power supplying part and a power receiving part are relatively apart. In addition, the power receiving part is required to be miniaturized in order to be installed into an implanted device. For the WPT, there are methods by microwave, by capacitive coupling and by magnetic field coupling. For a method based on the magnetic field coupling, there are two types, one is a method using an inductive coupling and the other is a method using a resonance phenomenon (resonant inductive coupling). From comparing the merit/demerit of each method, we will select the appropriate power supply method.

The features of each method for the WPT are shown in Table 1. The power supply by microwave is the method which transfers the power by emitting electromagnetic field from an antenna, however, it is difficult to transfer a power sufficient for lighting up the LEDs and in consideration the safety to the human body interfering on the transmission path. In an environment in which many peo-

ple are present like in a hospital, securing the safety of the human body is essential, therefore we determined that it is not appropriate to the application of this study. The power supply by capacitive coupling is the method which transfers the power via two capacitors and the capacitors can be formed with plates at a low cost, however they require relatively large metal plates to transmit power. For the application to the body-implanted equipment, the metal plates have difficulty in miniaturizing, therefore we also determined that it is not appropriate to the application of this study. The power supply by inductive coupling is the power transferring between transmitting side and receiving side in which two coils are strongly coupled. Under such condition, the power transmitting can be done efficiently, however the power supply efficiency relays strongly on the position of the coils. When positional relationship between the two coils changes as in this case, the two coils are not strongly coupled and stable power supply cannot be achieved. Therefore we also determined that it is not appropriate to the application of this study. The power supply by resonant inductive coupling is the power transmitting using the resonance phenomenon of an LC resonant circuit. The power can be transmitted from a distance of several 10 cm and the coils can be designed relatively small. We determine that it is the most suitable in an application, like in this study, which requires both miniaturizing and a power supply from relatively distant site, therefore the magnetic field resonance method is implemented for position detection of the implanted device in the human body.

### 2.2 Design of the Resonant Circuit

In order to implement the resonant inductive coupling method, the design of the resonant circuit is important. The resonant circuits are divided into 2 types, a series resonant circuit and a parallel resonant circuit, according to the connecting conditions of coils and capacitors. Since a resonant circuit is required for both transmitting and receiving sides, there are 4 patterns for the combinations of resonant circuits, and we have to select the most appropriate combination.

The series resonant circuit is the circuit where the coil  $L$

Table 1 Features of each wireless power transfer.

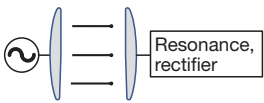
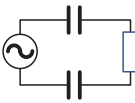
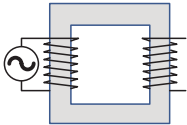
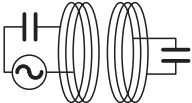
	Microwave	Capacitive coupling	Magnetic field coupling (Inductive coupling)	Magnetic field coupling (Resonant inductive coupling)
				
Feature	Power transmitting by using electromagnetic wave	Power transmitting by using two capacitors	Power transmitting by using two strongly coupled coils	Power transmitting by using LC resonance phenomenon
Transmission distance	Long distance (several m)	Short distance (several cm)	Short distance (several cm)	Middle distance (several tens of cm)
Applications			Transformer	Battery charge for electric vehicle

and the capacitor  $C$  are connected in series with the power source (see Figure 2 (a)). Figure 2 (a) shows the RLC serial resonant circuit which also has a resistance  $R$  connected in series as a loss. In such circuit, the current which flows through each of the coil, the capacitor and the resistance is always equal, however the voltage which occurs across the coil or the capacitor varies according to the frequency. When the current oscillating at the resonance frequency is applied to the circuit, the voltages occurring in each of the coil and the capacitor are equal in absolute value and reverse in sign. As a result, the voltages in the coil and the capacitor cancel each other, and it seems that there is only a series resistance connected to the power source in the circuit. The  $Q$  value, which indicates the efficiency of the series resonant circuit, is expressed by the following equation;

$$Q = \frac{1}{R} \sqrt{\frac{L}{C}} \quad (1)$$

the smaller the resistance, the higher the  $Q$  value, that is, the higher the efficiency of the resonant circuit.

In contrast to a series resonant circuit, the parallel resonant circuit is a circuit where the coil and the capacitor are connected in parallel with the power source (see Figure 2 (b)). Figure 2 (b) shows the RLC parallel resonant circuit which also has, in addition to the coil and the capacitor, a resistance connected in parallel as a loss. In such circuit, the voltage which is applied to each coil, capacitor and resistance is always equal, however the current which flows through the coil and the capacitor varies according to the frequency. When the voltage oscillating at the resonance frequency is applied, the currents flowing in each of the coil and the capacitor are equal in absolute value and reverse in sign. As a result, the currents in the coil and the capacitor cancel each other, and it seems that there is only a parallel resistance toward the power source. The  $Q$  value of the parallel resonant circuit is expressed by the following equation;

$$Q = R \sqrt{\frac{C}{L}} \quad (2)$$

the larger the resistance, the higher the  $Q$  value inversely with the case of serial resonant circuit.

The energy  $E$  which is stored in the resonant circuit per cycle for both serial and parallel resonant circuits is expressed by the following equation;

$$E = \frac{1}{2} LI^2 = \frac{1}{2} CV^2 \quad (3)$$

where  $I$  and  $V$  are maximum current in the coil and maximum voltage in the capacitor respectively. Since we cannot transmit the energy to the power receiving side more than the energy which is stored in the resonant circuit of the power supplying side, the equation (3) above is important to calculate the required transmitting power.

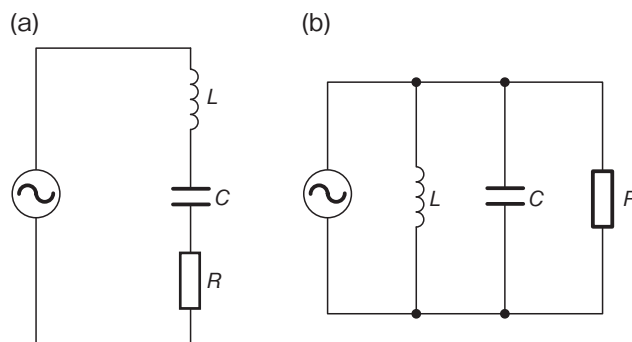

Figure 2 (a) Series RLC resonant circuit, (b) Parallel RLC resonant circuit.

First, we consider the resonant circuits which is suitable for the power receiving side. In the application this time, the load is the LEDs, therefore the  $R$  of the circuit shown in Figure 2 is replaced by the LEDs. The necessary current to light up the LEDs is several tens of mA at the very most and the necessary voltage to light up the LEDs is 2-3 V. In such a case, the effective resistance value which is obtained by dividing the voltage by the current while the LEDs are lighting up, is approximately several tens to several hundreds of ohms. In order to make a  $Q$  value higher in the serial resonant circuit, it is necessary to select a large  $L$  and a small  $C$  from the equation (1), however it is not realistic to form a large  $L$  on the power receiving side, where miniaturizing is required. On the other hand, for the parallel resonant circuit, from the equation (2), the high  $Q$  value is obtained when the  $R$  is large and higher  $Q$  value is also obtained when the  $L$  is small. Therefore, we implement the parallel resonant circuit which can achieve both high  $Q$  value and miniaturizing at the power receiving side. In general, the series resonant is suitable when the load has a low resistance and a relatively large current is applied, and the parallel resonant is suitable when the resistance is high and a relatively less current is applied, therefore the parallel resonance is suitable for the power receiving side in this respect.

Next, we consider the resonant circuits which is suitable for the power supplying side. The energy transmitted from the power supplying side will never exceed the energy stored in the resonant circuit of equation (3), therefore, it is necessary to apply a high voltage to the capacitor or to apply large current to the coil for the larger power transmission. The current control is easier in the series resonant circuit and the voltage control is easier in the parallel resonant circuit, therefore, the series resonant circuit is implemented when relatively large current can be controlled and the parallel resonant circuit is implemented when relatively large voltage can be controlled. For the application in this time, a low-voltage DC power supply such as batteries or cells is assumed, therefore it requires to design a way such as using a booster circuit in order to produce high voltage. On the other hand, it is possible to have large current with low voltage if a parasitic resistance of the LC resonant circuit at the power supplying side can be small. This time, the parasitic resistance of

the LC resonant circuit is not large, several tens  $\Omega$  at the most, and the sufficient power supply is available with the current of several hundred mA, a series resonant circuit is implemented.

### 2.3 Design of the Power Receiving Ring Circuit

An implanted device in a patient's body must keep the temperature increase within  $2^{\circ}\text{C}$  during operation, according to the standard for the implanted-medical devices. Some of the electric power received at the power receiving part does not contribute to LED emission and is converted to heat which leads to the temperature increase. Therefore, the electric power received from the power transmitting side needs to be consumed at the LED as much as possible in order to restrict the heat generation. The equivalent circuit in consideration of losses at the power receiving part is shown in Figure 3. The circuit in Figure 3 has additional resistance  $R_{LC}$  as a parasitic resistance to the coil  $L$  of the resonant circuit, and all loss of the LC resonant circuit is consumed in the resistance  $R_{LC}$ . The load of the power receiving part is the LED, so that the circuit is the resonant circuit in which the LEDs and the resistance are placed in parallel. The important factor to consider about the heat generation is the loss due to the resistance  $R_{LC}$ , which can be suppressed to avoid any unnecessary heat generation and reduce any temperature increase. The power consumption ( $J$ ) per cycle in the resistance  $R_{LC}$  is expressed by the following equation;

$$J = \frac{1}{2} R_{LC} I_{\max}^2 \quad (4)$$

here,  $I_{\max}$  is the maximum current that flows through the resistance  $R_{LC}$  and is equal to the maximum current flowing through the coil. From the equation (3), the maximum current going flowing through the coil is proportional to the voltage which occurs across the capacitor, therefore it is necessary to keep the maximum voltage of the LC resonant circuit as low as possible in order to suppress the heat generation. In the circuit shown in Figure 3, the voltage occurring in the capacitor and the voltage applied to the load such as LEDs are equal, therefore, low operating voltage is necessary for suppression of the heat generation. By a simple approximation of the electrical characteristics of LEDs, the LEDs are devices in which no current flows with the voltage below the so-called ON voltage, and in which a current flows and it emits with a voltage over the ON voltage, therefore the heat generation of the whole circuit is suppressed by the reduction of the ON voltage. In order to find the septum of the CV port accurately, several LEDs have to be placed around the septum, however, when the LEDs are connected in series, the on voltage becomes higher according to the number of the LEDs and the heat generation of whole circuit becomes larger. Therefore, at this time, we design the circuit to make heat generation small by connecting the LEDs in parallel.

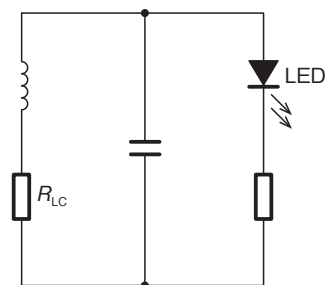

Figure 3 Circuit of the power receiving part.

## 3. SUBSTANTIATIVE EXPERIMENT

We designed the circuit according to the previous section and made a prototype sample of the power supplying part and the power receiving part. In this section, we will describe the results of confirmation tests if the designed circuit achieves the characteristics required for the implanted medical devices. Since the device implanted and used in the patient's body in practical is the power receiving part only, the result of the test for the power receiving part will be described in this section.

### 3.1 Visibility Test

In order to verify if the power receiving part practically implanted in the patient's body can be visible from the outside of the body, we verify, using domesticated pig, the visibility confirmation and the accuracy of the puncture by lighting LEDs. The experiments were performed under permission of the ethics committee of IV Tech. Lab, the experiment institution.

In order to simulate the usage environment, the power receiving part is mounted on the CV port (a dummy port) fabricated in our site. Two types of dummy ports were fabricated based on the size and the shape of commercial products: a dummy port with no LED (a conventional port) and a dummy port designed to have LEDs placed around the septum (a luminous CV port). The dummy port is made by a 3D printer, and the power receiving part and a silicone rubber septum for puncture are mounted onto the dummy port. Since there is no direct influence to the puncture, a catheter is not attached. The luminous dummy port fabricated is shown in Figure 4. It was confirmed that the LEDs mounted around the septum are lit by the WPT.

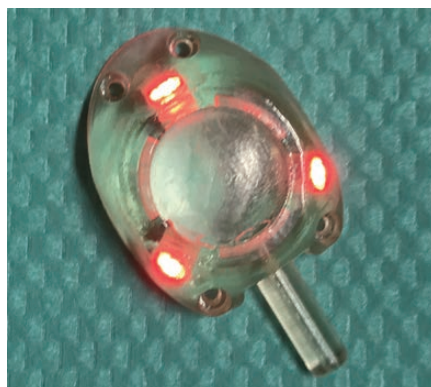
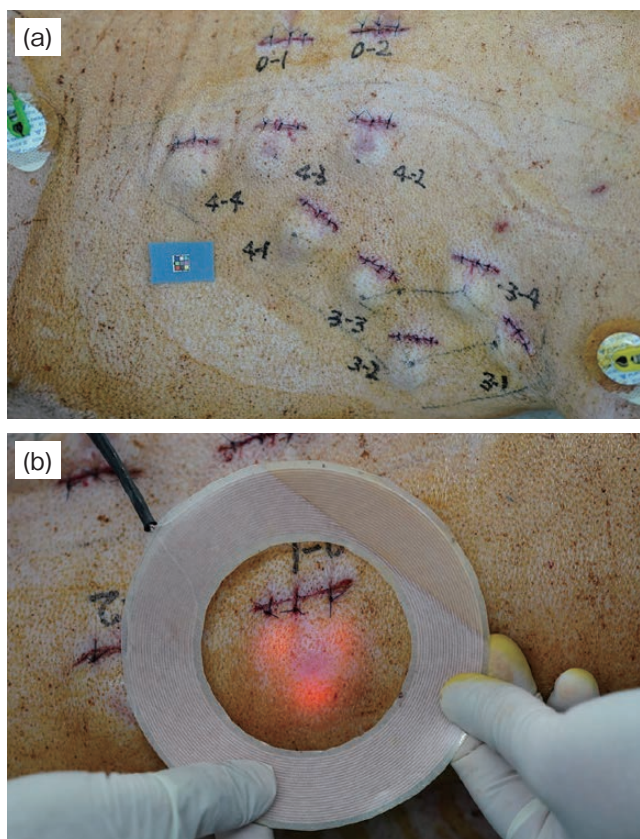

Figure 4 Photograph of a dummy luminescent CV port.



The condition of the implantation into a patient's body is simulated by an implantation of the dummy port onto a pig under the direction of Dr. Yoshihiro NISHIWAKI, then-Chief of Gastroenterological Surgery, and Dr. Masato OGIKU, Head Physician, Hamamatsu Medical Center. It has been reported that the optical characteristics of pig skin are similar to that of human<sup>2)-4)</sup>, and the thickness of the pig skin is different within 2-8 mm depends on the parts of the pig body, therefore the range of typical implant deepness when the CV port is implanted can be replicated. The luminous CV port practically implanted under the pig skin and the situation of the CV port with its LEDs lit by the WPT are shown in Figure 5. In Figure 5(a), several luminous CV ports are implanted under the pig skin, and in Figure 5(b), one of the implanted luminous CV ports is lighting practically. It is obvious from Figure 5(b), the implanted luminous CV port is visible from the outside when lit by the WPT.



**Figure 5** (a) Photograph of pig skin installed CV ports, (b) photograph of luminescent CV port .

The effect of the improved visibility by CV port lighting is evaluated based on the deviation of the puncture trace from the septum center. The measurements are evaluated for two conditions of the CV port implanting depth under the skin thickness of 3.5 mm and 6.8 mm. The puncture is performed also by doctors and nurses.

The photograph of the septum punctured practically with using luminous CV port is shown in Figure 6. The puncture traces correspond to the part where the septum is flawed, which is the black area in Figure 6.

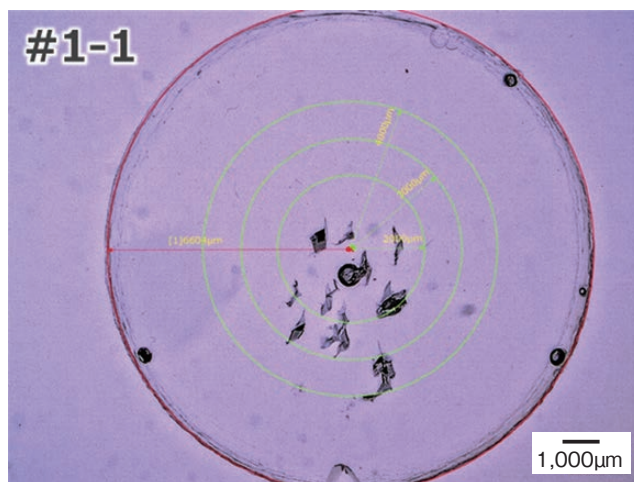

**Figure 6** Photograph of puncture trace in the septum.

Figure 7 shows the distribution deviation of the puncture trace from the septum center when the pig skin thickness is 3.5 mm. For the luminous CV port, about 50% of the puncture traces are present within 2 mm from the septum center. 94% of the puncture traces are present within 4 mm from the septum center. 6% of the puncture traces are present over 4 mm from the septum center. On the other hand for the conventional CV port, the puncture traces existing within 2 mm is 31% and within 4 mm is only 80%. The puncture traces existing over 4 mm are 20%. For a small CV port, there is a septum which diameter can be as small as 8 mm, therefore, if the deviation of the puncture traces are more than 4 mm from the septum center, it is possible that the puncture is not done correctly in the septum. In the present study, since the punctures which has deviation of 4 mm or more from the septum center are 6% for the luminous CV port and 20 % for the conventional port, it is considered that CV port lighting may enable safer punctures.

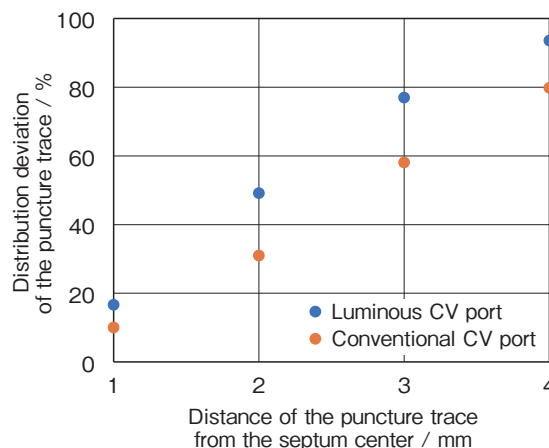

**Figure 7** Distribution deviation from the septum center (skin thickness: 3.5 mm).

Next, Figure 8 shows the distribution deviation of the puncture trace from the septum center when the pig skin thickness is 6.8 mm. 96% of the puncture traces are

within 4 mm from the septum center for the luminous CV port, and there is not a large difference compared with the result of a 3.5 mm pig skin thickness. On the other hand, in the case of conventional CV port, only 67% puncture traces exist within 4 mm from the septum center. The puncture traces existing over 4 mm are increased by more than 10% compared to the case with a big skin thickness of 3.5 mm. The thicker the skin, the more difficult it is to find the CV port by palpation, which may be the reason for the increase of the puncture positions exceeding 4 mm in the case of conventional non-luminous CV port. In the case of luminous CV port, since it is easier to find the septum center by the lighting around it, which may be the reason for the decrease as 4% of the puncture positions are exceeding 4 mm.

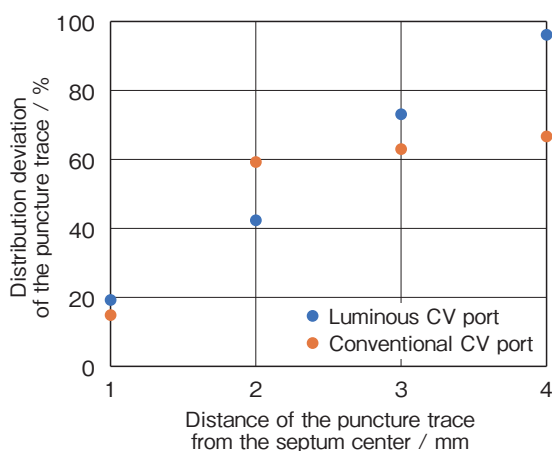
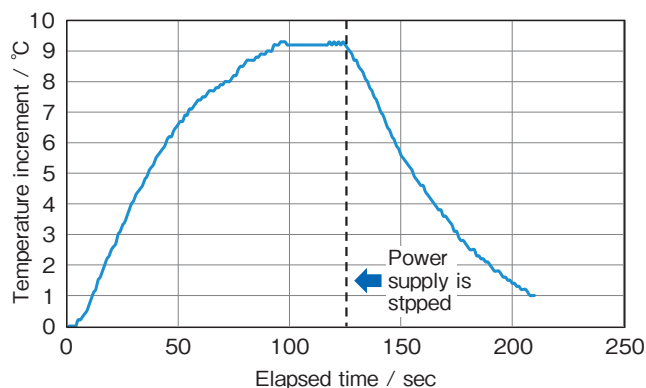

**Figure 8** Distribution deviation from the septum center (skin thickness: 6.8 mm).

As described above, by the luminescence, it becomes easier to detect the CV port and the septum center, and enables stable puncture. The luminous CV port is considered to be highly effective in reducing puncture errors, especially for the CV port installation in the thick skin area.

### 3.2 Heat Generation Test

The luminous CV port must keep the temperature increase within 2°C during operation, according to the standard for the implanted-medical devices. Since we are unable to measure the increase in the case of the luminous CV port directly in our site, we evaluate the heat generation of the power receiving part alone when the LEDs are lighting on. The measurement is performed in air and temperatures are measured by thermocouples. Figure 9 shows the measurement results when the LEDs are actually lighting for about 2 minutes. The lighting time (power supply time) of the LEDs is assumed to be about 2 minutes, therefore in the case of Figure 9, the power supply is stopped at 2 minute after the beginning of the power supply. The temperature increase of the power receiving part alone is within 10°C but is over the standard of 2°C.



**Figure 9** Result of heat generation of the power receiving part.

For the point at which the measured value exceeds the specified value, the difference between the measurement environment and the actual use environment should be considered. A biological phantom is often used as an example to simulate the actual operating environment of an implanted-medical device<sup>5)</sup>, but the biological phantom is composed of approximately 96% water. The water has a thermal conductivity of 0.602 W/mK and the specific heat of 4,182 J/kgK, and the thermal conductivity is twentyfold larger and the specific heat is fourfold larger in comparison to air of 0.026 W/mK and 1,006 J/kgK respectively. Therefore, the temperature increase can be suppressed compared to the measurement in air. There is the report that when the temperature increases in both air and a phantom are compared practically, the result is that the temperature increases in a phantom are suppressed about 20-30% in comparison to the one in air<sup>5)</sup>. In a product case, its power receiving part is installed inside of the CV port unit, therefore it can be considered that the heat capacity of only the CV port unit is increased, compared to the power receiving part alone, and the temperature increase is suppressed. When the temperature increase of the power receiving part is 10°C in air, it will be about 3°C measured in a biological phantom, and also it will be suppressed more in consideration of the heat capacity increase when installed in the CV port device. Therefore we determined that the 10°C or less temperature increase in air may not become a problem.

The confirmation tests in order to satisfy the standard for the implanted-medical devices must be performed on the CV port where the power receiving part is installed. We will continue to reduce more the consumption of power, and verify and evaluate again the power receiving part when being installed into a CV port practically.

## 4. FUTURE ENDEAVOR

For the power receiving part fabricated as above, we have achieved the suppression of the heat generation while ensuring the visibility. We have been continuing the evaluation of the luminous CV port and we could confirm that it is at the same level as the conventional CV port for MRI immunity. From now on, focusing to production, we

will proceed to study for more size reduction and installation process onto the CV port, and to evaluate the power receiving part installed into the CV port.

We also named this technology, lighting implanted-medical devices by the WPT described in this paper, as Tellumino and registered a trademark with its designed logo shown in Figure 10. We consider that this technology can be applied to other implanted-medical devices, and will continue to promote it to other medical devices.



Figure 10 Logo of “Tellumino”.

## 5. CONCLUSION

We achieved the visibility of the CV port, which is one of implanted-medical devices, using the Wireless Power Transfer (WPT). The visibility is confirmed by practically using pig skin and the evaluation for the heat generation is completed. With such technologies, we consider that the luminous CV port allows visual recognition over the skin, reduce the puncture accidents such as leakages of medications, and will lead to reduce the burden on nurses and patients. In addition, the development of the body implanted light-emitting devices using the WPT makes it possible to apply this technology to the other implanted devices. As described above, we will continue to develop the product which contributes to safety improvements to present medical technologies.

## REFERENCES

- 1) Guideline for the Evaluation of Wireless Power Transfer System for Implanted-Medical Devices, Issued by the Director of Office of Medical Device Evaluation Division, Pharmaceutical Safety and Environmental Health Bureau, Ministry of Health and Welfare, Notification No. 9, August 9, 2017. (in Japanese)
- 2) T. Kono and J. Yamada: *Int. J. Thermophys.*, Vol. 40, No. 5 (2019), 51.
- 3) T. Kono, N. Imanishi, K. Nozawa, A. Takashima, R.U. Maheswari, H. Gonome, and J. Yamada: *Biomed. Opt. Express*, Vol. 10, No. 8 (2019), 3747.
- 4) A. N. Bashkatov, E. A. Genina, and V. V. Tuchin: *J. Innov. Opt. Health Sci.*, Vol. 4, No. 1 (2011), 9-38.
- 5) T. Sato, F. Sato, H. Matsuki, K. Katayama, A. Ito: *J. Magn. Soc. Jpn.*, Vol.27, No.4 (2003), 603-606.